

# Assembly Instruction

## Step 14

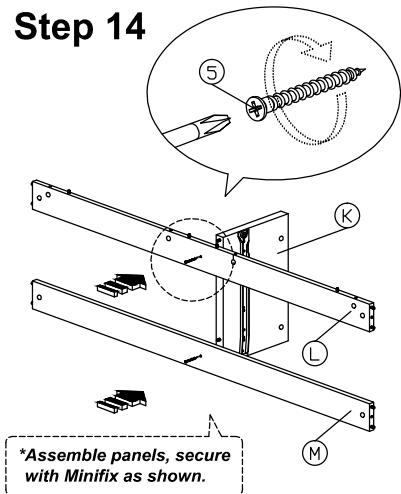

## Step 15

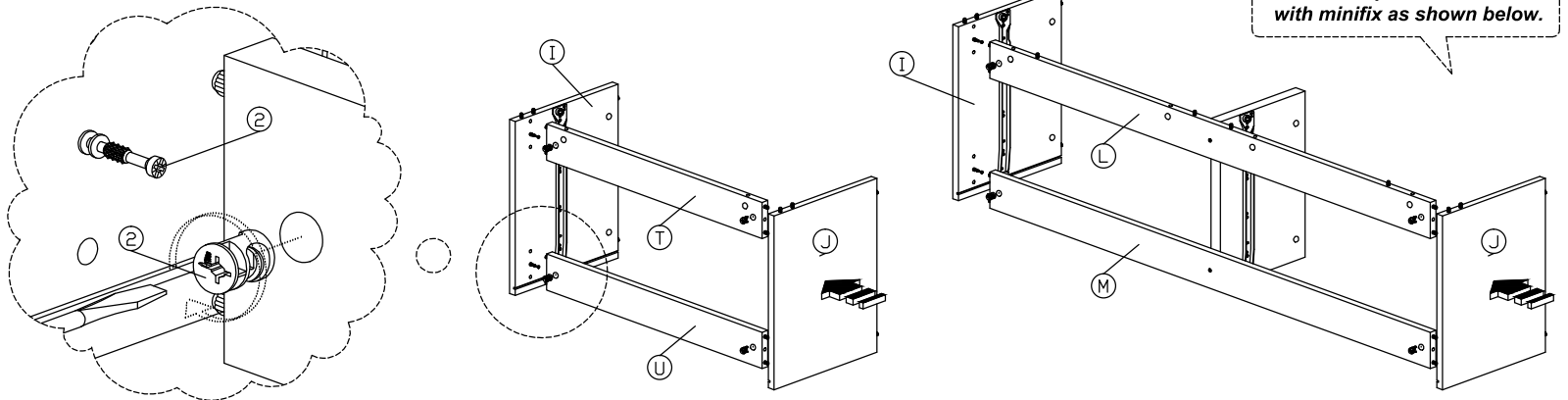

## Step 16

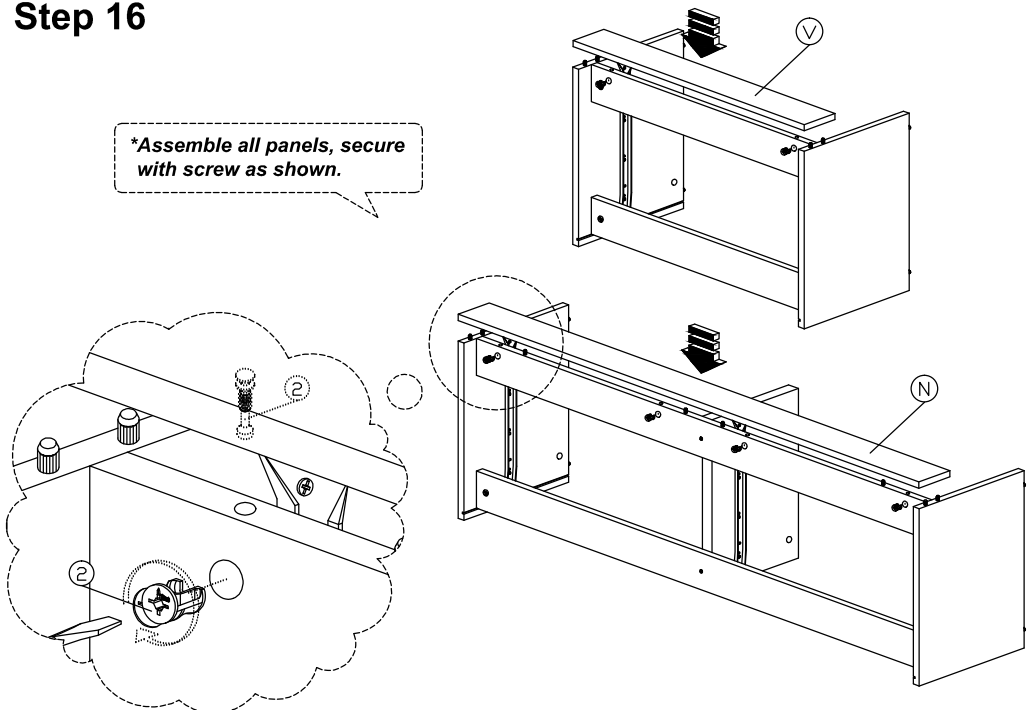

## Step 17

